

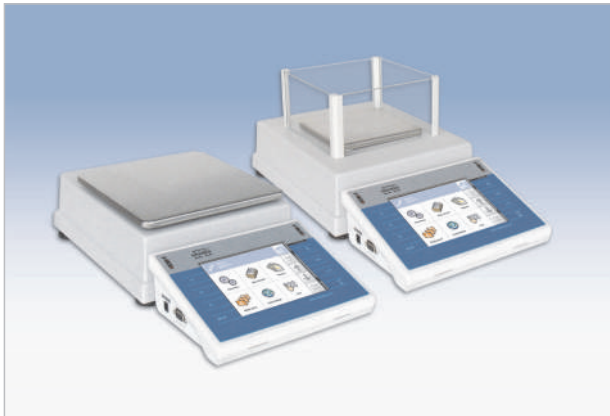







PRECISION BALANCES PS/Y



Precise balances of PS/Y are the response for the growing market demands concerning simple operation and maximum automation of the weighing process.

Measurement reliability and accuracy is assured by internal calibration triggered by time flow or temperature conditions.

Balances equipped in a new electronic modules and are operated using a touch panel covering a 5.7" colour graphic display. Y scales have implemented new easily operated software.

-  Counting pieces
-  Filling
-  Animal weighing
-  Density determination
-  Checkweighing
-  Percentage
-  Statistics
-  Formulation

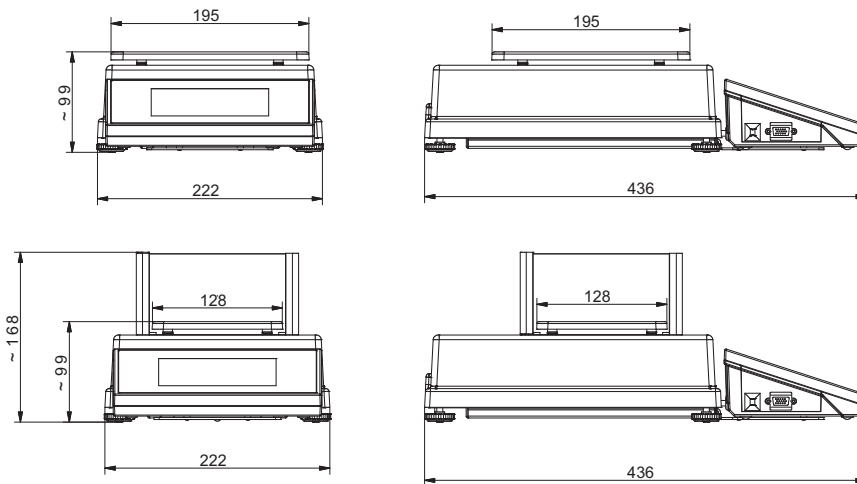

Technical data:

	PS 200/2000/Y	PS 250/Y	PS 450/Y	PS 750/Y	PS 1000/Y	PS 1500/Y	PS 2500/Y	PS 4500/Y	PS 6000/Y	PS 8000/Y**
Max capacity	200/2000 g	250 g	450 g	750 g	1000 g	1500 g	2500 g	4500 g	6000 g	8000 g
Minimal load	20 mg	20 mg	20 mg	20 mg	20 mg	500 mg	500 mg	500 mg	500 mg	500 mg
Readability	1/10 mg	1 mg	1 mg	1 mg	1 mg	10 mg	10 mg	10 mg	10 mg	10 mg
Tare range	-2000 g	-250 g	-450 g	-750 g	-1000 g	-1500 g	-2500 g	-4500 g	-6000 g	-8000 g
Linearity	±2/10 mg	±2 mg	±2 mg	±3 mg	±3 mg	±20 mg	±20 mg	±20 mg	±30 mg	15 mg
Repeatability	1/10 mg	1 mg	1 mg	1,5 mg	1,5 mg	10 mg	10 mg	10 mg	15 mg	±20 mg
Pan size	128×128 mm					195×195 mm				
Stabilization time	2 s / 1,5 s	2 s	2 s	2 s	2 s	1,5 s	1,5 s	1,5 s	1,5 s	1,5 s
Sensitivity drift	2 ppm/°C in temperature +18 - +30 °C									
Working temperature	+15 - +30 °C									
Power supply	230V / 11V AC or 120V / 11V AC									
Net weight/Gross weight	5/7,1 kg	4,1/6 kg	4,4/6,3 kg	4,4/6,3 kg	4,4/6,3 kg	5/7,1 kg	5/7,1 kg	5/7,1 kg	5/7,1 kg	3,4/5,3 kg
Packaging size	570×325×225 mm									

** external calibration

Additional equipment:

Anti-vibration table	Foot button for tare or print functions
"Kafka" thermal printer	Rack for under hook weighing
Needle printer "Epson"	LCD additional display
Citizen label printer	External rechargeable battery pack
Density determination kit for solids and liquids	Suitcase for balance
PC keyboard	Computer software: PW-WIN, RAD-KEY

RADWAG USA L.L.C.

19599 NE 10th Ave., Bay G, • North Miami Beach, FL, 33179 • USA • Tel: 1-305-651-3522 • Fax: 1-305-651-3523 • e-mail: office@radwagusa.com • website: www.radwagusa.com