

# Carbon and Water Analyzers

CW-800 | CW-800M | SurfaceC-800

ELTRA  
Fractional  
analysis of  
 $\text{CO}_2$  and  $\text{H}_2\text{O}$   
CW-800 series



# ELTRA

ELEMENTAL ANALYZERS

## Specialists for Elemental Analysis

ELTRA has been one of the leading manufacturers of elemental analyzers for more than 30 years. Starting with combustion analyzers for carbon and sulfur determination, ELTRA has extended its product range over the years with analyzers for oxygen, nitrogen and hydrogen as well as thermo-gravimetric analyzers. ELTRA instruments are used in industries such as steel, mining, automotive and aviation, construction materials and in universities for Research & Development.

**ELTRA is synonymous with high quality, customer-oriented solutions and efficient products. Thousands of satisfied customers worldwide are proof of the reliability of ELTRA analyzers.**



# Carbon and water analysis

Fractional analyzers like ELTRA's CW-800 or CW-800M easily and reliably determine different carbon species. In gypsum, for example, carbon occurs in two forms: bound to carbonate (TIC = Total Inorganic Carbon), and bound to organic compounds (TOC = Total Organic Carbon). Both values influence the gypsum quality in different ways.

Steel samples also require fractional carbon analysis. The total carbon content can be divided into a surface-bound and metal-bound part. The latter results from steel production whereas surface carbon occurs during steel processing (for example, oil coatings). While ELTRA's SurfaceC-800 analyzer allows for selective analysis of the surface carbon, the metal-bound carbon is detected with the CS-800.

## CO<sub>2</sub> | H<sub>2</sub>O Analyzers

### For organic and inorganic samples



ELTRA's CW-800 series uses combustion analysis for fractional carbon and water determination with different temperatures and gases. The instruments are equipped with a resistance furnace with a quartz glass furnace tube and apply a maximum temperature of 1,000°C.

**CW-800**

**04**

**CW-800M**

**06**

#### Applications CW-800 | CW-800M

**07**

### For inorganic samples



**SurfaceC-800**

**08**

The SurfaceC-800 features a wider furnace than the CW-800 also accepting larger metal sheets (32 x 145 mm). A maximum temperature of 1,000°C is applied to determine the surface carbon.

#### Applications SurfaceC-800

**10**

#### Software

**11**

#### Technical Data

**12**

## ELTRA also provides analyzers for:

### CS in organic/inorganic samples



The **CS-2000** is the only analyzer in the market which allows for C and S analysis in both inorganic and organic samples. This is made possible by ELTRA's Dual Furnace Technology (EDF) which combines induction and resistance furnace in one analyzer.

### ONH in inorganic samples



The **ONH-2000** is ideally suited for the quick simultaneous determination of oxygen, nitrogen and hydrogen in steel, cast iron, molybdenum, nickel, copper, zirconium, titan, ceramics and other inorganic samples.

### Thermogravimetry



The **Thermostep** analyzer allows for determination of different sample parameters such as moisture, volatiles, and ash in one single analysis cycle.

# Carbon and water analyzers

CW-800

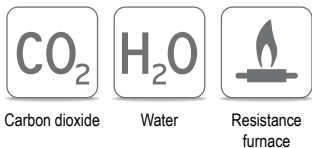

## The perfect analyzer for fractional carbon determination

### Benefits

- Simultaneous CO<sub>2</sub> and H<sub>2</sub>O determination
- Freely selectable temperature up to 1,000 °C
- Quartz tube for sensitive measurements

**ELTRA's CW-800 series is designed for fractional carbon and water analysis. The CW-800 is used for the determination of one single fraction (e. g. carbonate-bound carbon) whereas the CW-800M (M = Multiphase) utilizes ramping to determine different fractions.**

The CW-800 is the perfect analyzer for the fractional determination of carbon and water in organic and inorganic samples. Typical applications include carbonate analysis in cement products or TOC (Total Organic Carbon) analysis in soil. The CW-800 uses a resistance furnace with quartz tube, applying a maximum constant temperature of 1,000 °C which can be set in steps of 1 °C. It is possible to use nitrogen or oxygen as carrier gas. During the combustion process CO<sub>2</sub> and water are released from the sample into the heated quartz tube and are detected in two independent infrared cells. Customer-specific adjustments of the measuring range are possible for both cells. The typical analysis time for a 200 mg sample is about 2 to 3 minutes.

### Typical sample materials

**Cement, gypsum, lime, soil, minerals, slag and many more**

## Simple operation and quick results: CW-800

Operation of the CW-800 is simple and safe. The sample is weighed in a quartz boat on the interfaced balance and the weight is transferred to the linked PC. Manual weight entry is also possible. The boat is then placed on the loading head of the CW-800. When the analysis process is started, the user introduces the sample with a sample feeder into the combustion area, and CO<sub>2</sub> and H<sub>2</sub>O are released under the selected conditions (e.g. nitrogen as carrier gas, furnace temperature of 950°C).

The signals of the detectors and the instrument parameters are displayed on the PC monitor during analysis. Evaluation of the signals and output of the results is carried out automatically; all results can be transferred to a Laboratory Information Management System (LIMS). The CW-800 requires hardly any maintenance. The particle filters and chemicals which need to be exchanged are easily accessible.



Weighing the sample



Manual introduction of the sample into the furnace through the loading head



Display of analysis results

## Measuring principle CW-800

Temperature and carrier gas (nitrogen or oxygen) are set once for the analysis. Depending on the selected reaction conditions, H<sub>2</sub>O and CO<sub>2</sub> are released from the sample. With the carrier gas they first pass a particle filter and then the water infrared cell. In a next

step, water vapor is chemically adsorbed and CO<sub>2</sub> is detected in the second infrared cell. Depending on the configuration of the CW-800 it is also possible to use only the H<sub>2</sub>O or CO<sub>2</sub> cell.

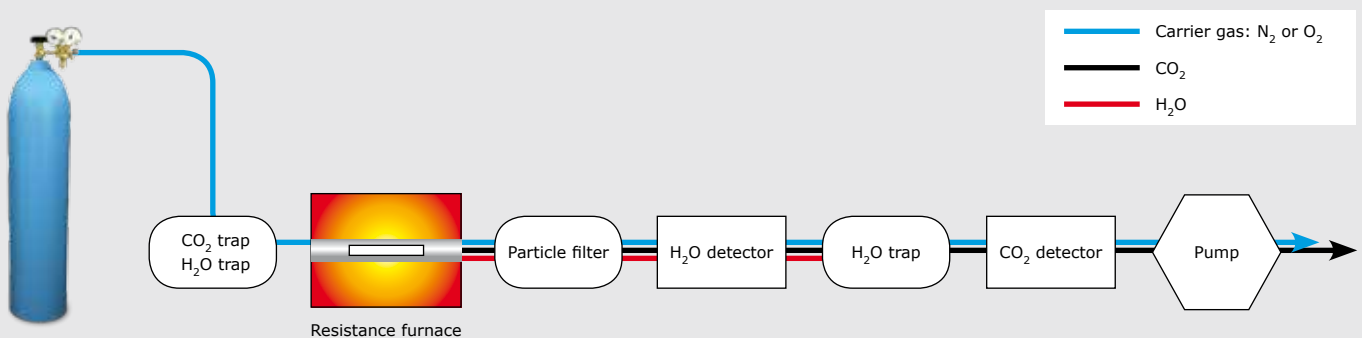

# Carbon and water analyzers

CW-800M

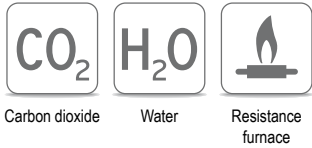

## Complete fractional analysis with CW-800M

### Benefits

- Freely programmable temperature profile
- Catalyst furnace for CO oxidation
- Split furnace allows for accelerated cooling

**The CW-800M is ideally suited to determine different carbon and water fractions in one single analysis. The analyzer is equipped with two carrier gas connections allowing for alternating use of nitrogen and oxygen in one analysis cycle.**

The CW-800M (Multiphase) permits changing the carrier gas and temperature during analysis, something which is not possible with the CW-800. The software allows the setting of up to 5 different temperatures with a maximum of 1,000°C. These settings are stored in a Standard Operating Procedure (SOP). Thus, samples are easily and reliably analyzed for their carbon and water fractions. Whereas the CW-800 determines TOC (Total Organic Carbon) and TIC (Total Inorganic Carbon) in two separate measurements, the CW-800M allows for simultaneous analysis in one sample.

### Technical Details CW-800M

The CW-800M is equipped with a catalyst for post-oxidation which is directly connected to the quartz tube. Thus it is possible to oxidize CO, which can be a product of incomplete combustion, to CO<sub>2</sub> which is reliably detected with the infrared cell. After the SOP has been carried out, the furnace of the CW-800M automatically opens to ensure fast cooling of the quartz tube.

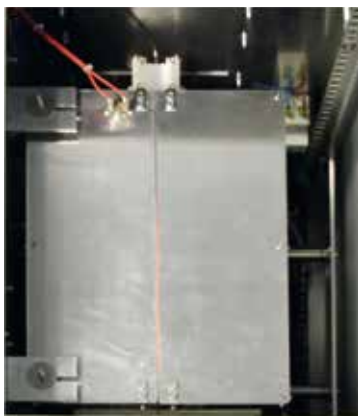

Closed furnace

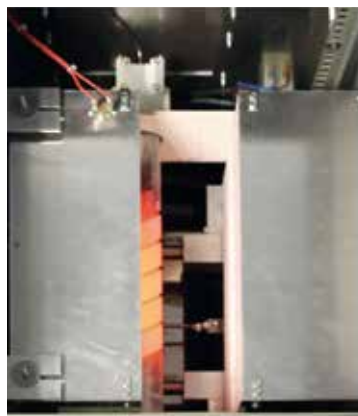

Opened furnace



## Typical sample materials

Cement, gypsum, lime, soil, minerals, slag, waste and many more



ELTRA's CW-800 series quickly, precisely and safely analyzes the CO<sub>2</sub> and H<sub>2</sub>O contents of organic and inorganic sample materials. The instruments apply furnace temperatures of up to 1,000°C and different carrier gases.

## Example CW-800:

### Determination of carbonate in cement

The quality of cement is characterized by the water contents and carbonate-bound carbon. In the example below the cement sample was measured in the CW-800 at 1,000°C under nitrogen atmosphere to analyze the water and carbonate content.

#### Measurement results

Five 250 mg samples  
Analysis time 70 seconds

Parameter	Mean value (%)	Standard deviation
CO <sub>2</sub> content	7.1	0.03
H <sub>2</sub> O content	1.1	0.01

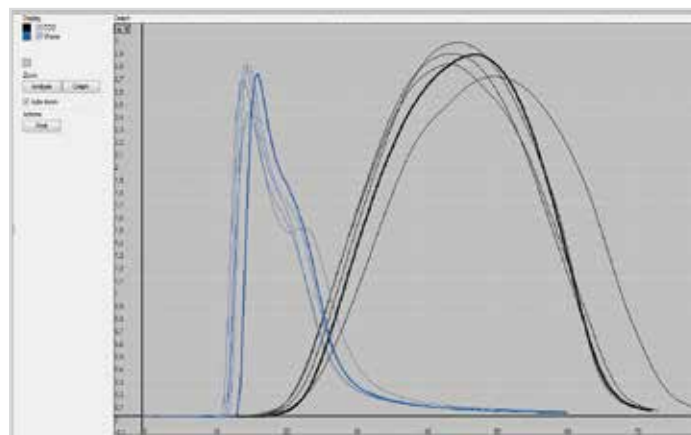

## Example CW-800M:

### Fractional measurement of water and carbon in calcium oxalate

The possibility to change atmosphere and temperature during analysis allows for a wide range of applications (chemicals, soil, waste). The example shows the fractional decomposition of calcium oxalate which releases water and carbon at different temperatures under oxygen atmosphere.

#### Measurement results calcium oxalate

Ten 60 mg samples  
Analysis time 40 minutes

Parameter	Temperature	Percent by weight	Standard deviation
H <sub>2</sub> O	200°C	12.2 %	0.11
CO	450°C	19.2 %	0.15
CO <sub>2</sub>	850°C	30.1 %	0.12

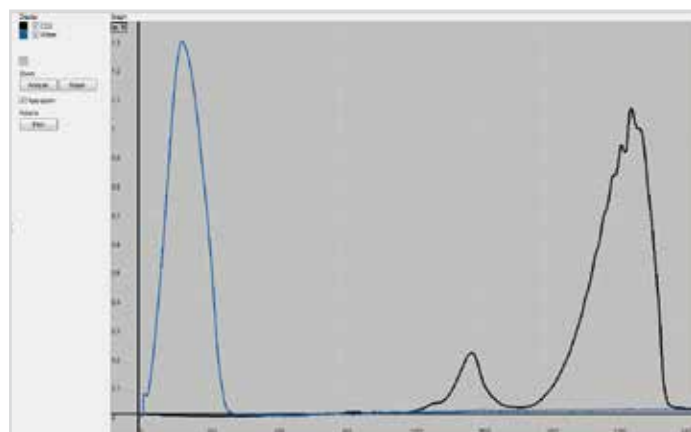

# Surface Carbon Analyzer

SurfaceC-800



Carbon dioxide Resistance furnace

**ELTRA**  
For larger sized samples  
SurfaceC-800



## Benefits

- Wide furnace for samples up to 32 x 145 mm
- Freely selectable temperature up to 1,000 °C
- 2 IR cells provide wide measuring range
- Unique loading head

## Convenient determination of surface carbon

**Apart from the metal-bound carbon, the carbon content of the sample surface is also important. For example, undesired contaminations of the surface influence the adhesion of paint. In some cases however, surfaces are also specifically treated, e. g. with oil to avoid corrosion. ELTRA's SurfaceC-800 is designed for the safe and reliable determination of surface carbon.**

The analyzer features a wide resistance furnace with quartz tube and two independent CO<sub>2</sub> infrared cells. Thanks to the wide measuring range up to 1,000 µg/cm<sup>2</sup>, a great variety of sample materials can be analyzed for their carbon content. The temperature can be set up to 1,000 °C in steps of 1 °C. The typical carrier gas is oxygen. The strength of the SurfaceC-800 is the reliable measurement of very low concentrations of surface carbon which is due to the fact that the analyzer accepts larger sample volumes.

## Typical sample materials

**Steel, iron, copper, refractory metals and many more**



## Simple operation and quick results: SurfaceC-800

ELTRA has developed a special loading head to avoid contamination through the wide furnace opening. It consists of a quartz closure (1) with a reduced diameter, compared to that of the combustion tube, to effectively minimize gas exchange with the analyzer's interior. The sample (2) is placed on a particularly wide quartz boat (3) and the analyzer is closed with the boat holder (4). The incoming oxygen now purges the loading head and quartz boat of ambient CO<sub>2</sub>. When the analysis starts, the quartz boat containing the sample is introduced into the hot zone with the

help of a sample feeder and the surface carbon oxidizes to CO<sub>2</sub>. When the analysis is finished the sample, which is free of surface carbon, is removed and the quartz closure (1) remains in the combustion tube of the SurfaceC-800. Evaluation of the signals and output of the results is carried out automatically; all results can be transferred to a Laboratory Information Management System (LIMS). The SurfaceC-800 requires hardly any maintenance. The particle filters and chemicals which need to be exchanged are easily accessible.

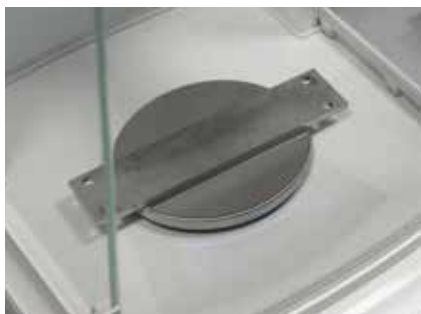

Weighing the sample

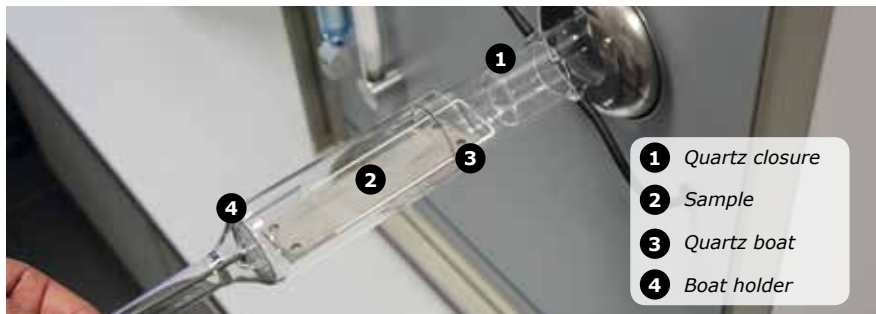

Manual introduction of the sample into the furnace

## Measuring principle SurfaceC-800

After the sample is introduced into the resistance-heated furnace of the CW-800 its surface carbon is oxidized in an oxygen stream at temperatures of 1000°C max. to CO and CO<sub>2</sub>. A pump sucks these released gases through a catalyst which oxidizes CO

to CO<sub>2</sub>. This catalyst ensures that the carbon species which are not completely oxidized are detected in the two consecutive CO<sub>2</sub> infrared cells. A particle filter protects the infrared cells from contamination with dust.

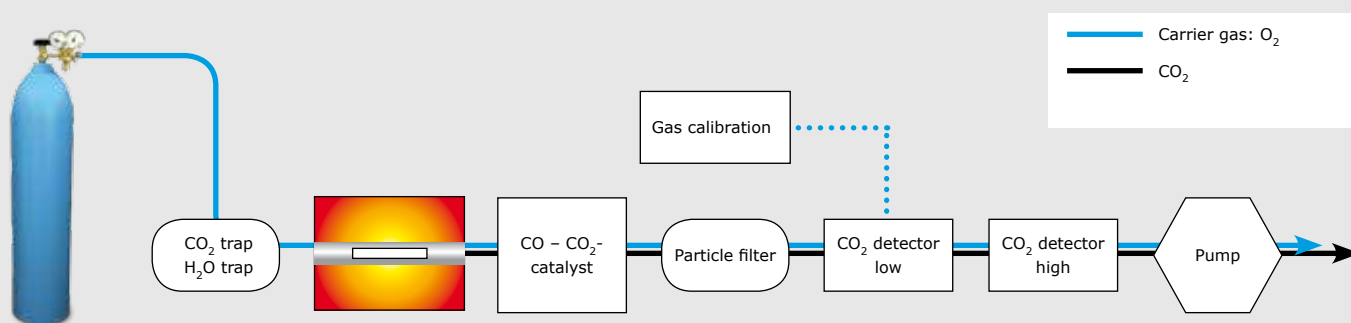

# Applications – Inorganic

## SurfaceC-800

The SurfaceC-800 with its resistance furnace allows for convenient analysis of the surface carbon content in metal samples. The wide furnace and the maximum temperature of 1,000°C make the analyzer suitable for a variety of applications.

### Typical sample materials

**Steel, iron, copper, refractory metals and many more**



### Example SurfaceC-800: Carbonates

The SurfaceC-800 can be calibrated with CO<sub>2</sub> gas as well as with synthetic carbonate standards, as calibration materials for metal surfaces are not always easily available. The graphic shows typical results for a 100 mg sample.

#### Measurement results carbonates

Ten 100 mg samples  
Analysis time 3 – 5 minutes

C content (%)	Result incl. standard deviation
0.12%	0.12 ±0.002
0.53%	0.53 ±0.003
1.02%	1.02 ±0.01

### Metal surfaces

For a reliable determination of both low and high concentrations of surface carbon, the SurfaceC-800 uses two consecutive infrared cells. The software switches automatically from one measuring range to the other to provide reproducible results for every sample.

#### Analysis of sheet steel

The graphic shows typical measurement results for thin sheet steel (here: 0.3 x 30 x 130 mm) with a low surface carbon content. The carbon concentration detected in the sensitive CO<sub>2</sub> cell is 2.4 ±0.2 mg /m<sup>2</sup>.

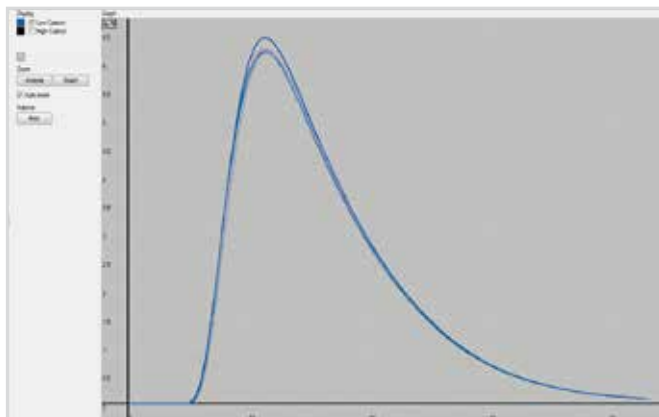

#### Analysis of copper

The graphic shows typical measurement results for the analysis of copper tubes (here: 3 x 130 mm) with a high surface carbon content. The carbon concentration detected in the CO<sub>2</sub> cell designed for high concentrations is 130 ±2 mg C/m<sup>2</sup>.

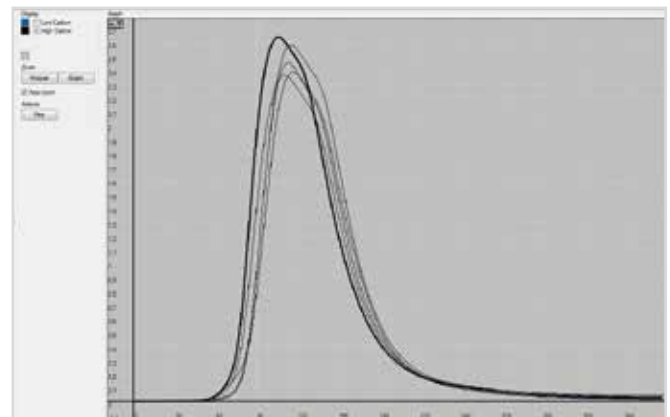

## PC control with Windows<sup>®</sup>-based software

**ELTRA's instrument software ensures convenient control and operation of the analyzers CW-800, CW-800M und SurfaceC-800. It is multilingual, easy to understand and provides the following features:**

- Custom layouts: user-defined display of windows and storage of different layouts
- User profiles with multi-level access: creation of different hierarchy levels with different authorizations
- Sample ID memory and serial numbering of samples
- Storage of analysis results in data base: the data of each analysis is stored and can be called up later for reviews, reports, statistical calculations or recalculation of results with modified parameters
- Programmable data base filter: user-defined selection of existing analysis data by sample name, date, ID or other parameters
- Visualization of statistical data and results consistency
- Peak separation calculation for fractional analysis
- LIMS communication and data export
- One point or multi point calibration
- Barometric pressure compensation
- Simultaneous calibration of more than one measuring range
- Automatic linearity correction
- Applications memory and display of maintenance intervals: individual configuration of maintenance intervals
- Hardware diagnostics display and print-outs of technical reports



### CW-800M: Defining a standard operating procedure

The software of the CW-800M permits the definition of a standard operating procedure with different temperatures, holding times and carrier gases. It is possible to define up to 5 ramps with individual parameters. Thus the parameters moisture (105°C), TOC (500°C) and TIC (950°C) are easily determined in one single analysis.

# Technical Data

## CO<sub>2</sub> - | H<sub>2</sub>O Analyzers

CW-800

CW-800M

SurfaceC-800



Measuring ranges	200 mg sample	200 mg sample	50 cm <sup>2</sup>
Low CO <sub>2</sub> measuring range	0 - 70%	0 - 70%	0.1 - 100 µg C/cm <sup>2</sup>
High CO <sub>2</sub> measuring range	-	-	1 - 1,000 µg C/cm <sup>2</sup>
H <sub>2</sub> O measuring range	0 - 20%	0 - 20%	-
Sensitivity	200 mg sample	200 mg sample	50 cm <sup>2</sup>
CO <sub>2</sub> measuring range	0.0001 % CO <sub>2</sub>	0.0001 % CO <sub>2</sub>	0.1 µg C/cm <sup>2</sup>
H <sub>2</sub> O measuring range	0.0001 % H <sub>2</sub> O	0.0001 % H <sub>2</sub> O	-
Accuracy	200 mg sample	200 mg sample	50 cm <sup>2</sup>
CO <sub>2</sub> measuring range	±0.02 % CO <sub>2</sub> or ±1 % of measured value	±0.02 % CO <sub>2</sub> or ±1 % of measured value	0.2 µg C/cm <sup>2</sup> or ±1 % of nominal value (low measuring range) 1 µg C/cm <sup>2</sup> or ±1 % of nominal value (high measuring range)
H <sub>2</sub> O measuring range	±0.02 % H <sub>2</sub> O or ±1 % of measured value	±0.02 % H <sub>2</sub> O or ±1 % of measured value	-
General data			
Analysis time	2 - 3 minutes	2 - 30 minutes	1 - 5 minutes
Furnace	Resistance furnace with quartz tube up to 1,000 °C		
Power supply	230 V AC ±10 %; 50 /60 Hz, 10 A, 2.3 KW		
Weight	65 kg		
Dimensions (W x H x D)	55 x 80 x 60 cm		
Chemicals	CO <sub>2</sub> trap sodium hydroxide, H <sub>2</sub> O trap magnesium perchlorate	CO <sub>2</sub> trap sodium hydroxide, H <sub>2</sub> O trap magnesium perchlorate, copper oxide	CO <sub>2</sub> trap sodium hydroxide, H <sub>2</sub> O trap magnesium perchlorate, copper oxide
Measuring principle	Infrared absorption for CO <sub>2</sub> and H <sub>2</sub> O	Infrared absorption for CO <sub>2</sub> and H <sub>2</sub> O	Infrared absorption for CO <sub>2</sub>
No. of gas connections	1 (typically nitrogen <sup>1</sup> )	2 (oxygen and nitrogen <sup>1</sup> )	1 (typically oxygen <sup>1</sup> )
Interfaces	serial and USB		
Accessories	Balance resolution ±0.1 mg Computer, monitor, printer (exact specifications on request)		

<sup>1</sup>Purity of 99.5 %, in the low measuring range purity of 99.95 % is recommended.

**ELTRA**  
ELEMENTAL ANALYZERS



Eltra GmbH  
Retsch-Allee 1-5  
42781 Haan, Germany

Phone +49 21 04/23 33-400  
Fax +49 21 04/23 33-499  
E-Mail info@eltra.com  
Internet www.eltra.com

part of **VERDER**  
scientific